Configura[®] Comfort

Information & Assessment Form



USER GROUP

To provide comfortable seating to users with mild to moderate postural requirements, to help reduce the formation of pressure ulcers and help to stand or sit users with limited mobility.

APPROPRIATE FOR:

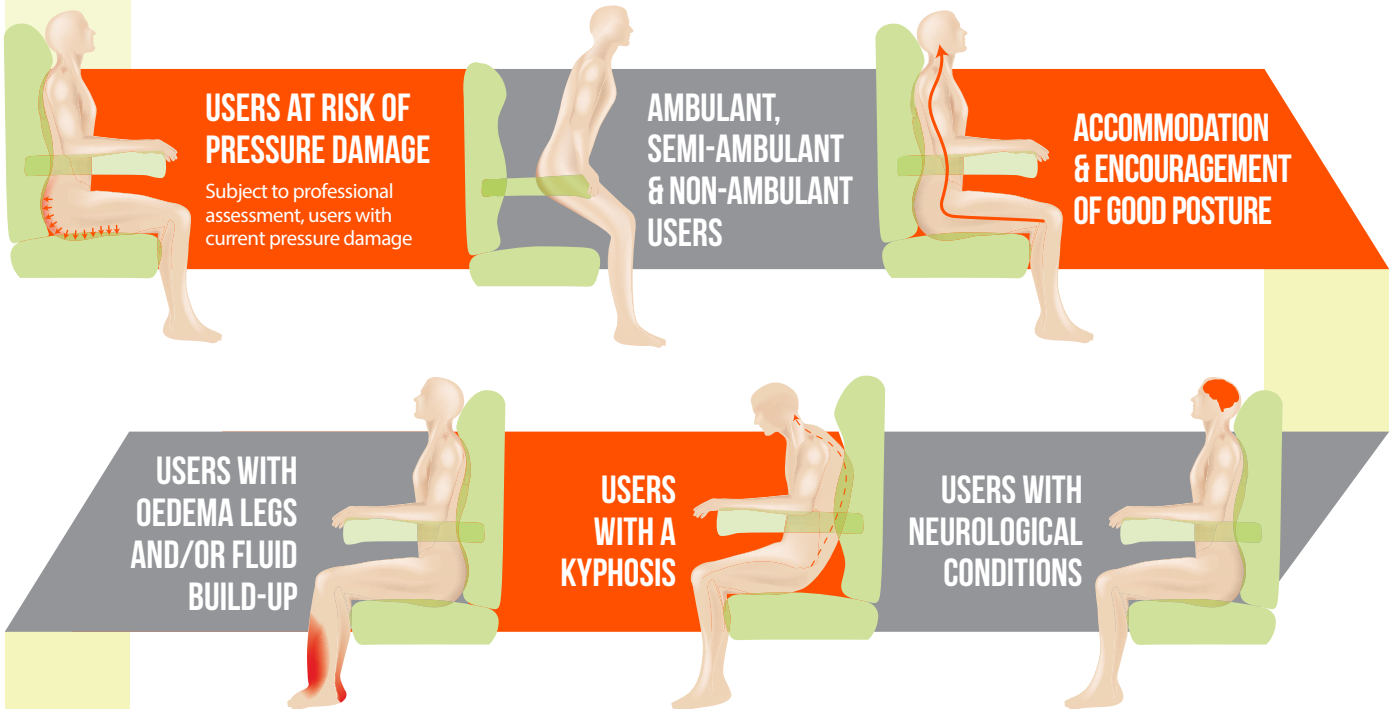

NOT APPROPRIATE FOR:

- 1** Demanding postural requirements
- 2** Users with fixtures and contractures
- 3** Users with a limited extension at the knees
- 4** Users who need to be transported from room to room
- 5** Bariatric users

INTENDED ENVIRONMENT



Domestic use



Care homes or nursing homes

STANDARD CHAIR SPECIFICATION

Configura® Comfort is the latest innovation from Accora and provides an unprecedented level of functionality and cost effectiveness.

Comfort is the result of acting on feedback collected from our customers over the past 5 years and it includes many features you have been asking for as standard.



'Reduced shear' recline to maximise pelvic stability

Integrated self-supply overlay for easy integration of existing cushions*

Compatible with transfer aids including Cricket, ReTurn 7500 and Moliift Raiser

Knock down design for easier storage and single person delivery

Pressure reducing fabric on backrest and armrest as standard

Colour matched vapour permeable vinyl

Castors for easy manoeuvrability

More depth adjustment options using backrest brackets. Reduces the need for depth adjustment kits

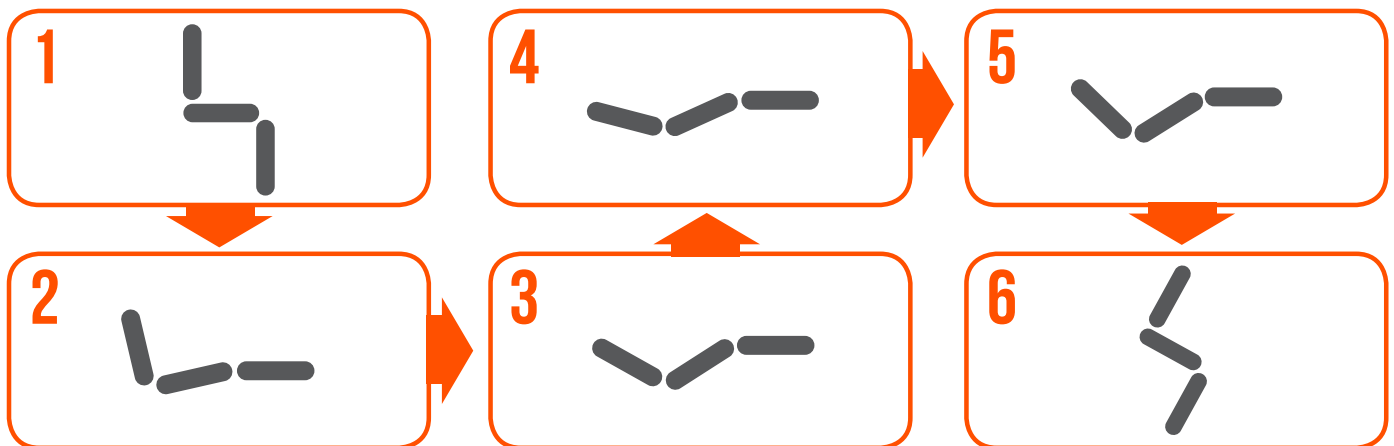

**For further information on the integrated self-supply overlay please see page 11.*

PRESCRIBER DETAILS

Name:

Department:

Address:

Telephone:

Email:

USER DETAILS

Name:

Address:

Telephone:

Email:

User weight:

Pressure Care:

Posture:

Mobility:

Diagnosis:

Prognosis:

Transfer method:

Current seating:

Problems with current seating:

Notes:

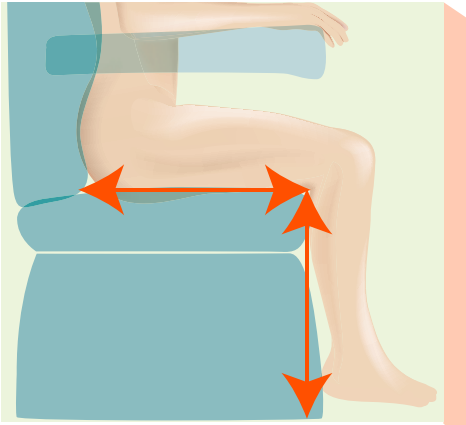

SIZE

Key thoughts:

- 3 measurements are required for selecting a chair; seat depth, seat height and seat width – see below drawings for clarity.
- When selecting a chair size, prioritise the chair measurements in the following order: seat depth, seat height then seat width. This will ensure the selected size is the right overall proportion for the user
- If you cannot find the size you need, check out the other chairs in our range or contact us as we may be able to supply a special size.

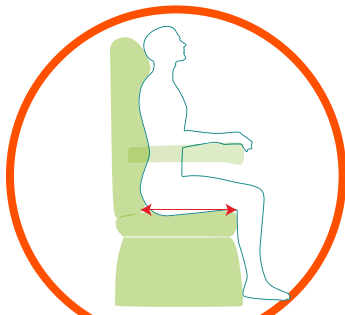

Seat depth

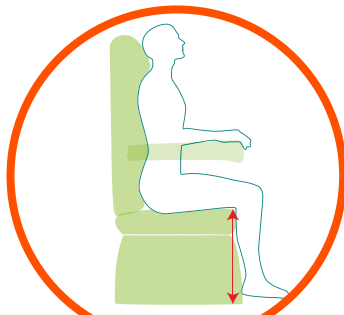

Seat height

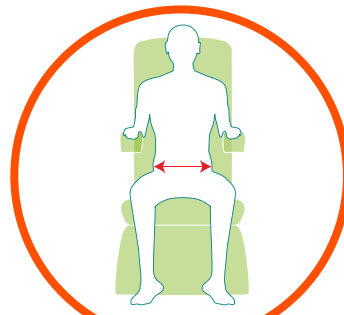

Seat width

Chair Size	Part Number	Seat Depth	Seat Height	Seat Width	Weight Capacity
SMALL	CR5422	457 mm (18")	406 mm (16")	457 mm (18")	130 kg
			431 mm (17")*		
		508 mm (20")	457 mm (18")**		
MEDIUM	CR5424	457 mm (18")	457 mm (18")	508 mm (20")	160 kg
			482 mm (19")*		
		508 mm (20")	508 mm (20")**		
LARGE	CR5426	457 mm (18")	457 mm (18")	559 mm (22")	160 kg
			482 mm (19")*		
		508 mm (20")	508 mm (20")**		

Position	Part Number
* Position 1	CA2421
** Position 2	CA2422

*Includes 1" Height Adjustment Kit CA2421.

**Includes 2" Height Adjustment Kit CA2422.

Seat depth is adjustable by 50 mm (2") as standard without extra parts.

SIZE ADJUSTMENT OPTIONS

Description	Long description	Part number		Select
25 mm (1") Height Adjustment Kit	Increases seat height 1" (25mm) or 2" (50mm), fits all sizes.	25mm - CA2421		<input type="checkbox"/>
50 mm (2") Height Adjustment Kit	Castors are raised off the ground when height adjustment kit is used	50mm - CA2422		<input type="checkbox"/>
50 mm (2") Depth Adjustment Kit	Decreases depth by further 51 mm (2").	CA2416		<input type="checkbox"/>

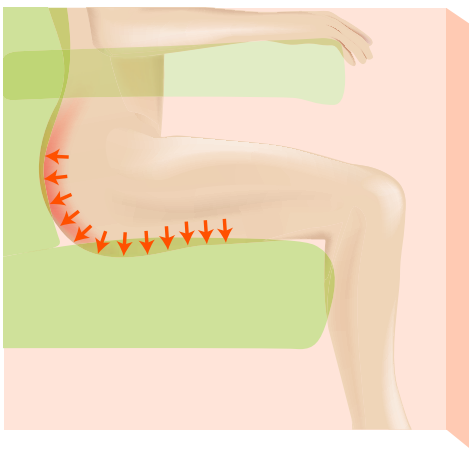

PRESSURE

Key thoughts:

- Selection of pressure cushions is a clinical decision which involves many variables including a risk assessment tool. Professional input from a Tissue Viability Nurse or District Nurse may be required at this stage.
- Vapour permeable fabric as standard on seat base, legrest, backrest and armrests.

PRESSURE CARE OPTIONS

Description	Long description	Part number		Select
Visco (std)	Prevention: Heat sensitive memory foam moulds to the user providing maximum support and pressure reduction. Suitable for users who are at risk of pressure damage. 160kg (25 stone) weight capacity.	N/A - standard part		<input type="checkbox"/>
Integrated Self Supply	Allows integration of self-supply cushion of approximate dimensions 17.5" x 17.5" x 3". (Professional input required. See page 11 for instructions).	N/A - standard part		<input type="checkbox"/>
Cushionair - Alternating Seat Cushion with Pump	Management: powered air cushion for users who have developed pressure damage. Weight capacity: 160 kg.	Fits all sizes CA2400		<input type="checkbox"/>

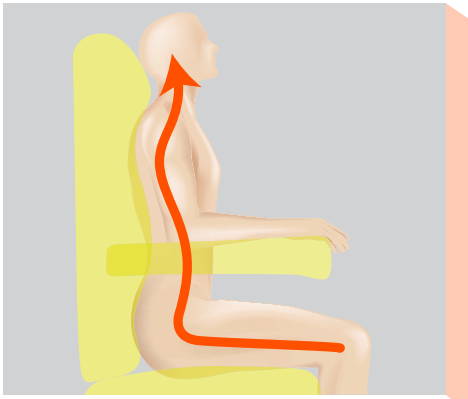

POSTURE

Key thoughts:

- Tilt-in-space can significantly improve midline sitting so increased lateral support may not be necessary if the user tends to slump mildly to one side.
- The Multi-adjustable Pillow Backrest is more adjustable than the Lateral Support Backrest and Adjustable Lateral Support System because filling can be removed to accommodate different postural requirements.

POSTURE MANAGEMENT OPTIONS

Description	Long description	Part number		Select
Multi-adjustable Pillow Backrest (std)	Accommodation: accommodates posture that has already developed i.e. kyphosis; our most popular backrest.	N/A Standard Part		<input type="checkbox"/>
Lateral Supports	Accommodation: used under the Multi-adjustable Pillow Backrest cushions to provide moderate postural support Sold as each.	CA2413		QTY 1 <input type="checkbox"/> QTY 2 <input type="checkbox"/>
Lateral Support Backrest	Encouragement: encourages a good midline sitting position for users whose posture is flexible.	Small CA2406 Medium CA2407 Large CA2408		S <input type="checkbox"/> M <input type="checkbox"/> L <input type="checkbox"/>
Adjustable Lateral Support Backrest	Management/correction: contoured foam backrest with adjustable Velcro Lateral Supports. Provides more aggressive lateral support and mild positioning/correction. Supplied with breathable, pressure reducing fabric.	Small CA2410 Medium CA2411 Large CA2412		S <input type="checkbox"/> M <input type="checkbox"/> L <input type="checkbox"/>
Profiled Headrest	Suitable for users with reduced lateral head control. Fits over the shoulders.	Fits all sizes CA2419		<input type="checkbox"/>
2-Button Handset	Suitable for Cognitive Impaired person e.g. dementia (Chair comes Standard w/ 4-button Handset).	Fits all Chair Sizes SC2316		<input type="checkbox"/>

continued overpage

EXTRAS

Description	Long description	Part Number		Select
Armrest overhang on outside (std)	Provides a good grip to assist the user rolling from side to side for easier fitting of slings.	Standard Part		<input type="checkbox"/>
Armrest overhang on inside	Reduces width between armrests by approximately 38 mm (1.5"). Provides extra arm and elbow support if the user is 'pear shaped' or very thin.	Standard Part		<input type="checkbox"/>
Right hand control (std)	N/A	Standard Part		<input type="checkbox"/>
Left hand control	N/A	Standard Part		<input type="checkbox"/>
Carer control	Fitted to backrest out of user reach	Standard Part		<input type="checkbox"/>
Rise (std)	23° of tilt. The most frequently used rise setting. This provides a gentle, progressive movement.	Standard Part		<input type="checkbox"/>
Medium rise	14° of tilt. There is not a specific user group for this setting - it is normally used if 'Rise' or 'Flat Rise' is inappropriate.	Standard Part		<input type="checkbox"/>
Flat rise	2° of tilt and 254 mm (10") of rise, used for users with Muscular Dystrophy who need to lock knees before transferring. (Not available on Small chair)	Standard Part		<input type="checkbox"/>
Legrest Setting 1.	Standard Position	Standard Part		<input type="checkbox"/>
Legrest Setting 2.	Standard Position + 25 mm (1")	Standard Part		<input type="checkbox"/>
Legrest Setting 3.	Standard Position + 50 mm (2")	Standard Part		<input type="checkbox"/>

TECHNICAL SPECIFICATION

- To provide comfortable seating
- To raise a user from a sitting to a standing position
- To lower a user from a standing to a sitting position
- To tilt in space a user

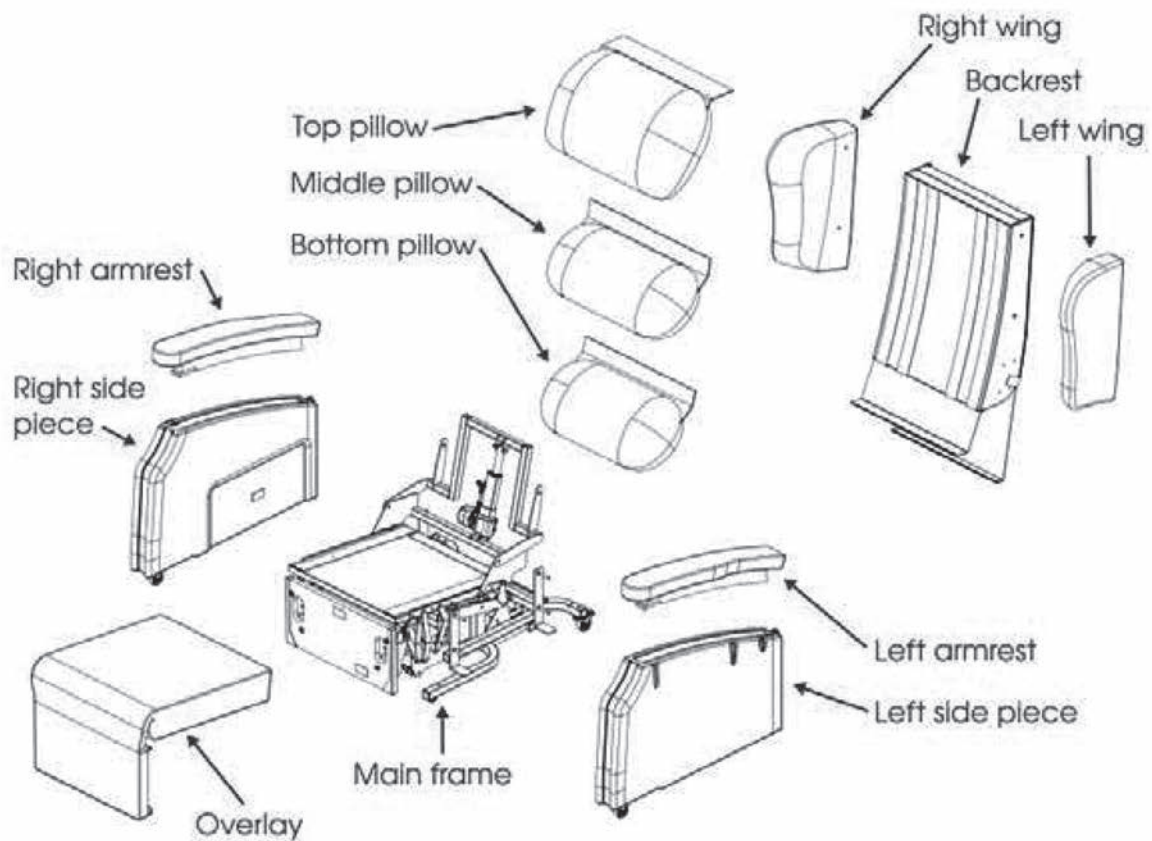

Figure 1. Spare parts of Configura® Comfort 1 Chair

OVERALL DIMENSIONS

	SMALL	MEDIUM	LARGE
WIDTH	711 mm (28")	762 mm (30")	812 mm (32")
LENGTH - UPRIGHT POSITION	940 mm (37")	940 mm (37")	940 mm (37")
LENGTH - RECLINE POSITION	1702 mm (67")	1702 mm (67")	1702 mm (67")
HEIGHT	1092 mm (43")	1143 mm (45")	1143 mm (45")
MASS	65 kg (143 lbs)	68 kg (150 lbs)	71 kg (156 lbs)

SPECIFIC DIMENSIONS

	SMALL	MEDIUM	LARGE
SEAT HEIGHT	406 mm (16")	457 mm (18")	457 mm (18")
SEAT HEIGHT WITH (HAKS)	457 mm (18")	508 mm (20")	508 mm (20")
SEAT WIDTH	457 mm (18")	508 mm (20")	558 mm (22")
SEAT DEPTH POSITION	457 mm (18")	508 mm (20")	508 mm (20")
ARMREST HEIGHT	180 mm (7")	180 mm (7")	180 mm (7")
RISE HEIGHT TO FRONT OF CHAIR			
STANDARD	546 mm (21.5")	508 mm (20")	508 mm (20")
MEDIUM	622 mm (24.5")	572 mm (22.5")	572 mm (22.5")
FLAT	NA	711 mm (28")	711 mm (28")
CHAIR TO WALL / FURNITURE	457 mm (18")	483 mm (19")	483 mm (19")
SAFE WORKING LOAD	130 kg	160 kg	160kg
BACK HEIGHT	700 mm	700 mm	700 mm

CLEANING INSTRUCTIONS FOR THE FABRIC

Clean and care for the fabric on a regular basis and it will maintain its condition and appearance.

The new generation of Microfibre cleaning cloths without soap are extremely effective for general care and maintenance. You can also wipe clean regularly with a damp cloth to remove dust particles and light soiling. It is recommended to vacuum the upholstery once a week.

Most stains can be removed by wiping clean. Remove spillages promptly (within 15 minutes) with cold water. For extreme soiling control use a 5% Sodium Hypochlorite (Bleach) solution.

Do not machine wash or dry clean.

Do not apply other chemicals such as polish, solvents or stain remover.

INTEGRATED SELF-SUPPLY OVERLAY

The integrated Self Supply Overlay comes as standard on all chairs.

This allows for easy integration of existing cushions.

The size of the aperture is 445 mm x 445 mm x 76 mm (17.5" x 17.5" x 3").

This means the height of the seat and armrests remain unchanged when using another cushion.



STEP 1

Remove the backrest cushions.



STEP 2

Unzip the cushion cover to expose the foam.



STEP 3

Pull the foam out carefully, starting at the rear and cut the perforations at the front.



STEP 4

This leaves the cut out for the existing cushions to be inserted. Insert the cushion and re zip the cover.



At Enable we source quality, affordable and innovative products globally and have them available for fast delivery. But we do more than just provide products.

We give the knowledge and support to help our customers grow their business and deliver better life care.



ENABLE LIFECARE PTY LTD

T 1300 370 370

enablelifecare.com.au